

BILL OF MATERIAL
MATERIAL LISTED FOR ONE UNIT OR ASSEMBLY

PART NO.	NO. REQ.	DESCRIPTION	MAT'L.	REMARKS
7SA - STAIR ASSEMBLY - 10 REQUIRED				
ch1a	ONE	MC12 x 10.6 x 10'- 8 1/8"	A36	SEE DETAIL THIS DWG.
ch2a	ONE	MC12 x 10.6 x 10'- 8 1/8"	A36	SEE DETAIL THIS DWG.
ch1b	ONE	MC12 x 10.6 x 0'- 7 5/16"	A36	SEE DETAIL THIS DWG.
ch2b	ONE	MC12 x 10.6 x 0'- 7 5/16"	A36	SEE DETAIL THIS DWG.
a1	2	L 3 x 3 x 3/8 x 0'-3" (SHIP LOOSE)	A36	
a2	2	L 3 x 2 x 3/8 x 0'-5" (SHIP LOOSE)	A36	
p1	2	PL 1/4" x 1 1/2" x 0'-8"	A36	
p2	2	PL 1/4" x 1 1/2" x 0'-5"	A36	
ts1	18	L 1 1/4 x 1 1/4 x 3/16 x 0'-10"	A36	
ts2	20	L 1 1/4 x 1 1/4 x 3/16 x 0'-3"	A36	
ts5	4	L 1 1/4 x 1 1/4 x 3/16 x 0'-2"	A36	
tp1	9	PLATE 12 GA. x 22 1/4" x 3'-6" (BENT)	A36	SEE DETAIL THIS DWG.
tp2	ONE	PLATE 12 GA. x 18 1/2" x 3'-6" (BENT)	A36	SEE DETAIL THIS DWG.
tp3	ONE	PLATE 12 GA. x 6 1/2" x 3'-6" (BENT)	A36	SEE DETAIL THIS DWG.

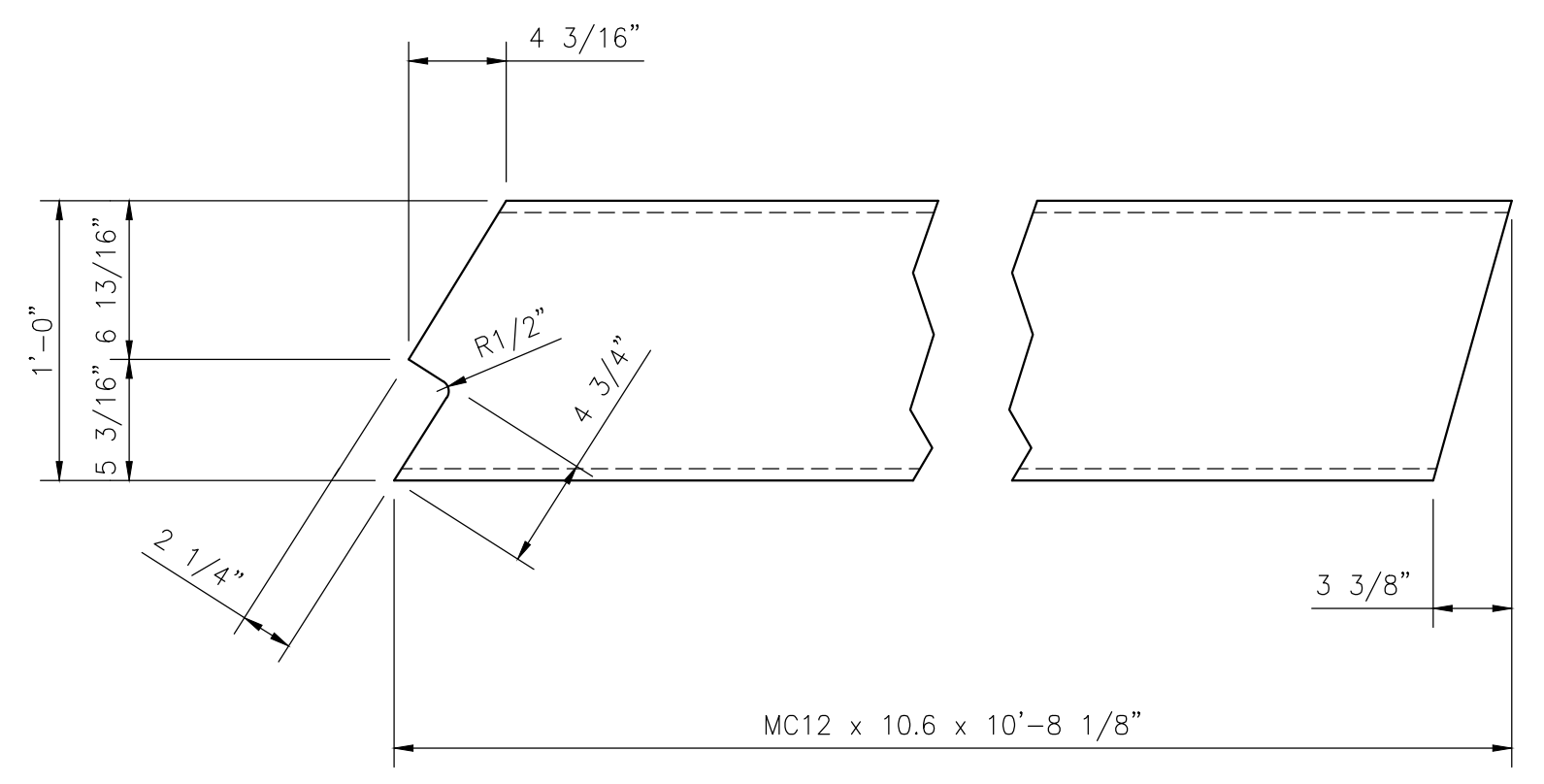
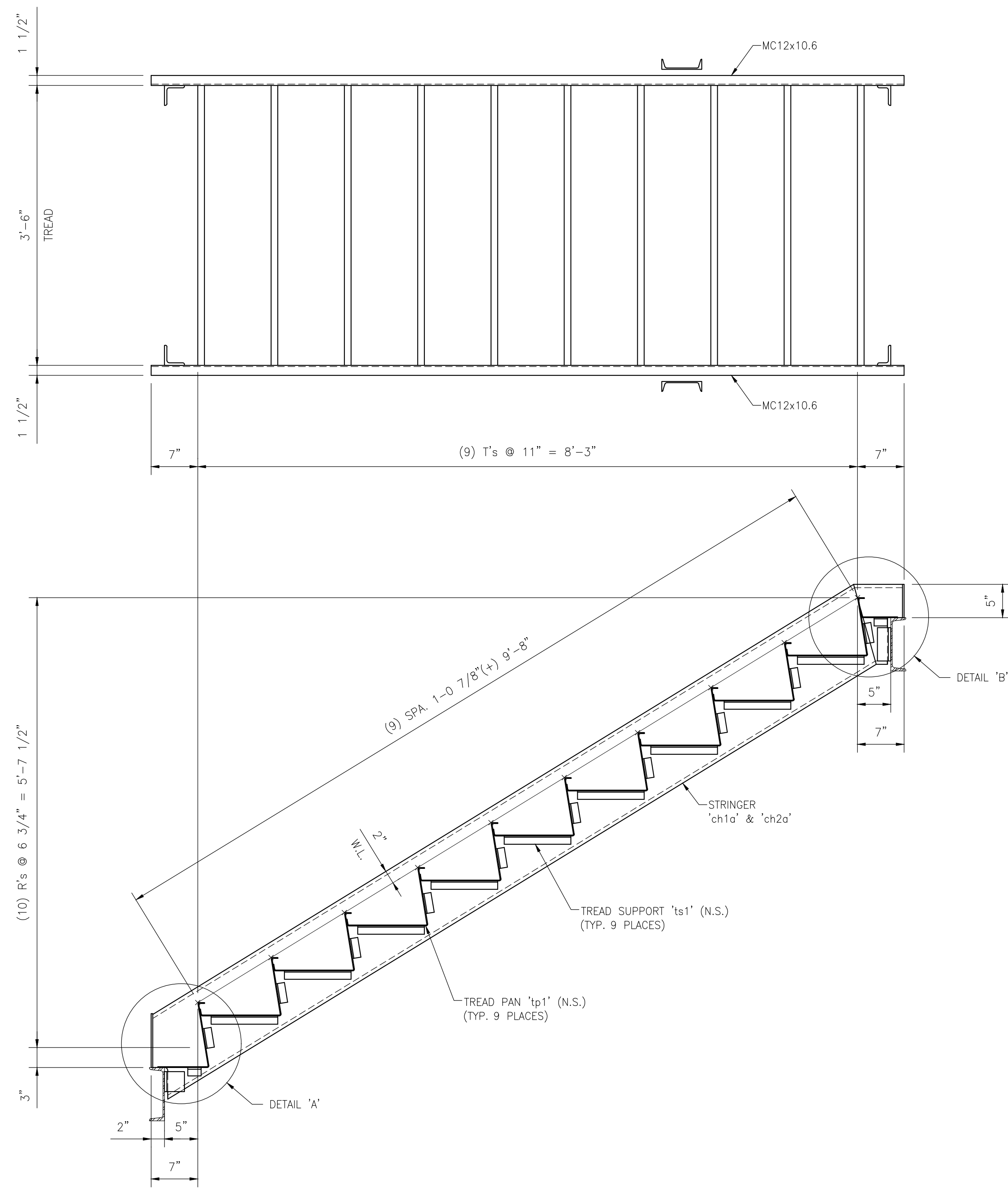

DETAIL OF 'ch1a' (AS SHOWN)
SCALE: 1 1/2"=1'-0"

DETAIL OF 'ch2a' (OPP. HAND)
SCALE: 1 1/2"=1'-0"

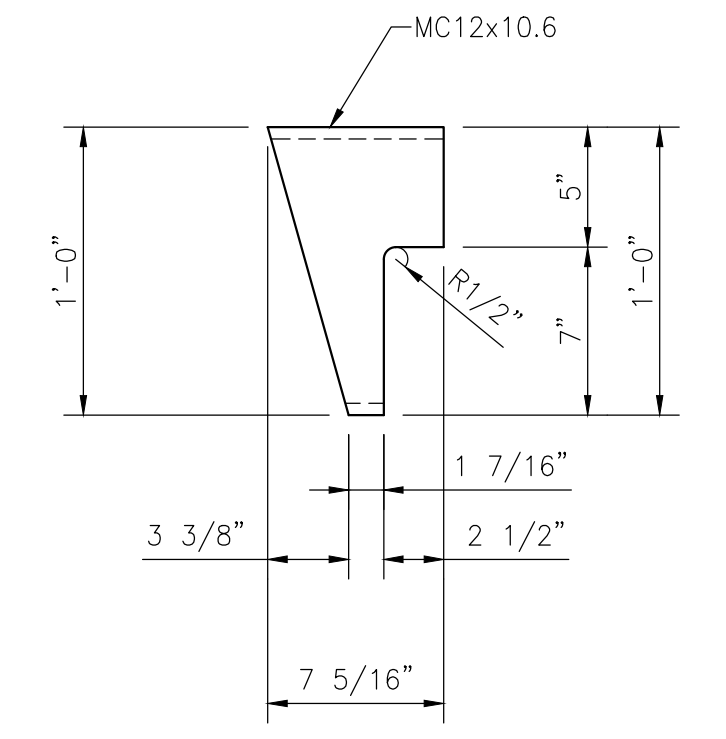

DETAIL OF 'ch1b' (AS SHOWN)
SCALE: 1 1/2"=1'-0"

DETAIL OF 'ch2b' (OPP. HAND)
SCALE: 1 1/2"=1'-0"

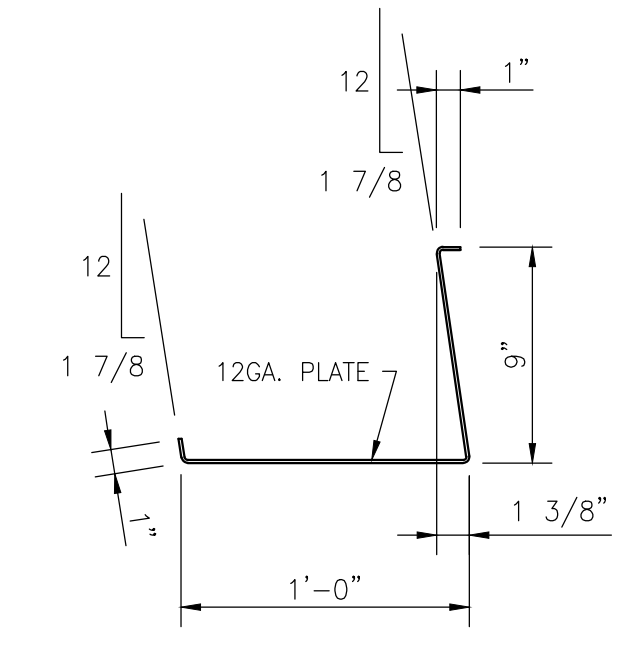

DETAIL OF 'tp1'
SCALE: 1 1/2"=1'-0"

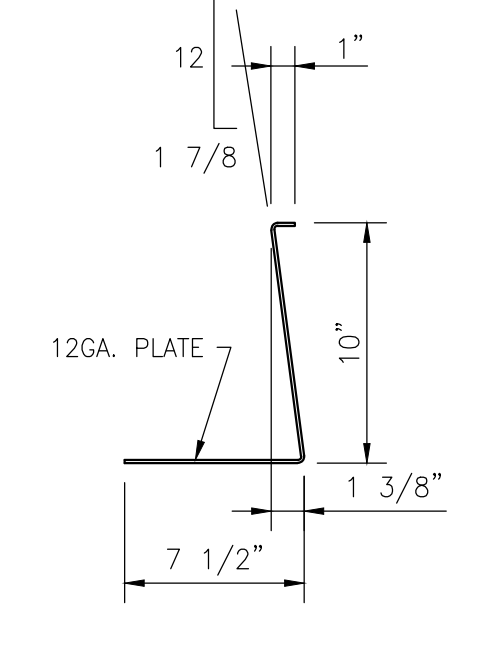

DETAIL OF 'tp2'
SCALE: 1 1/2"=1'-0"

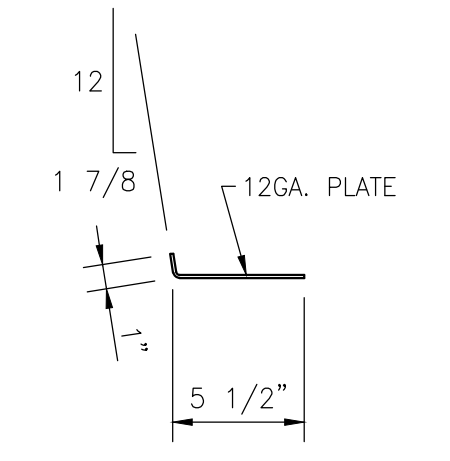

DETAIL OF 'tp3'
SCALE: 1 1/2"=1'-0"

'7SA' - STAIR ASSEMBLY - 10 REQUIRED
SCALE: 1"=1'-0"

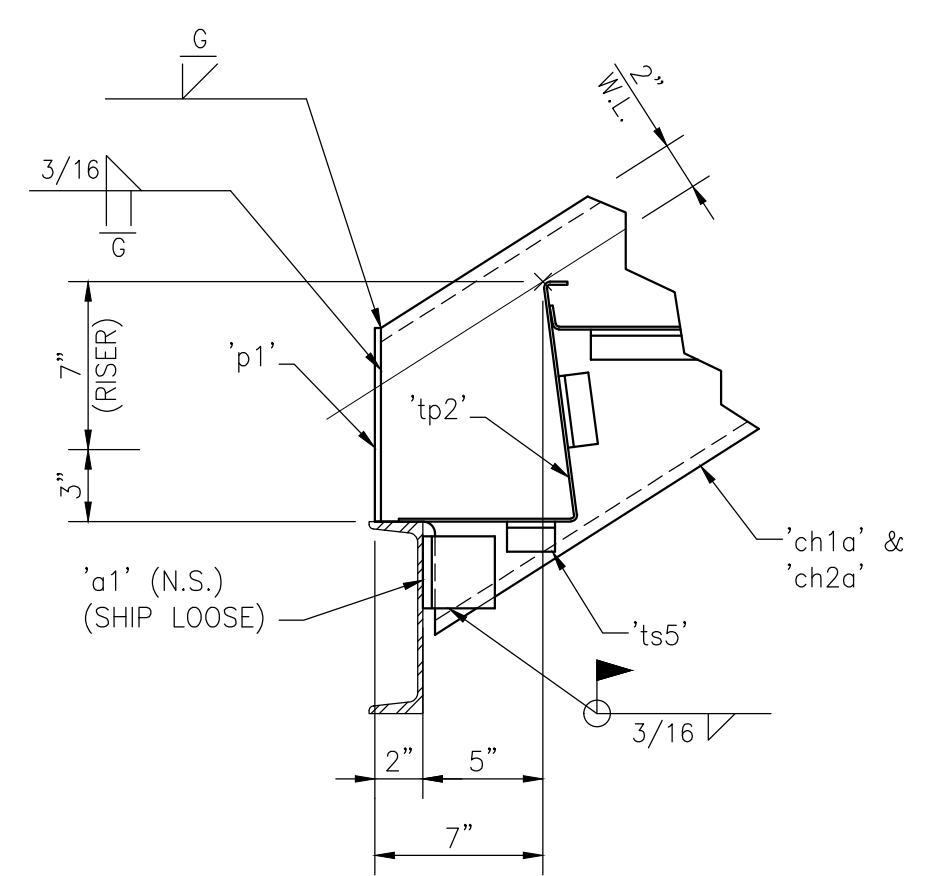

DETAIL 'A'
SCALE: 1 1/2"=1'-0"

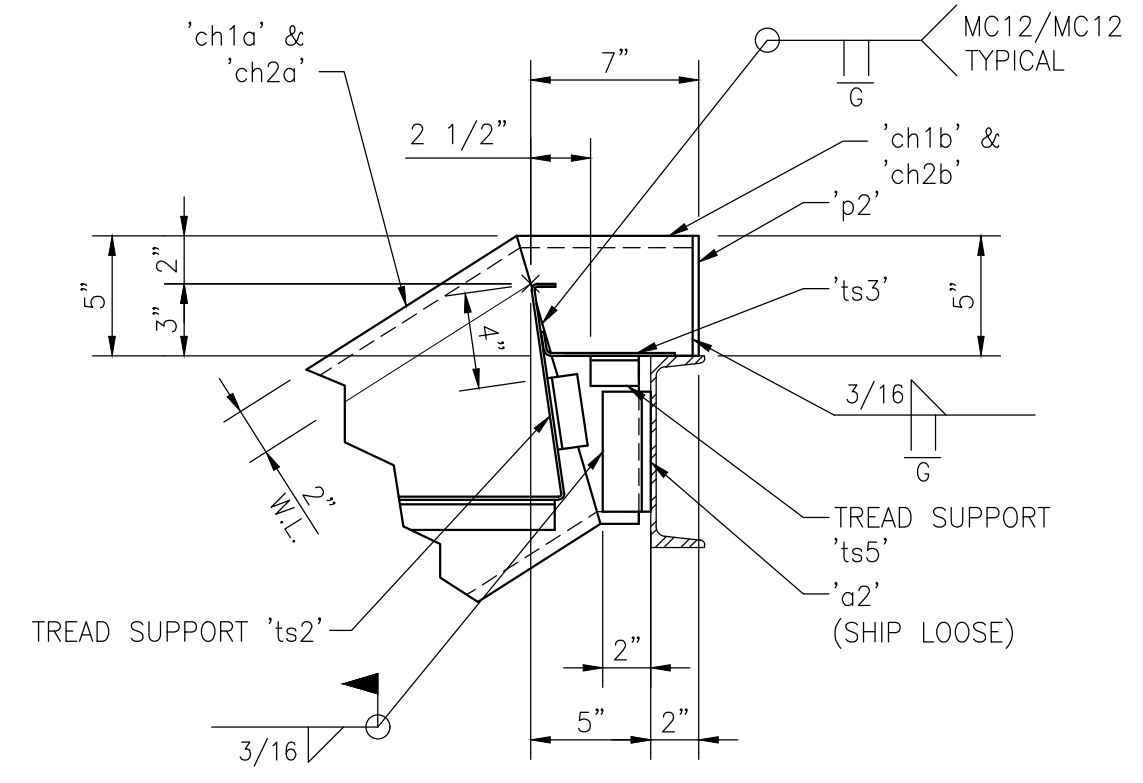

DETAIL 'B'
SCALE: 1 1/2"=1'-0"

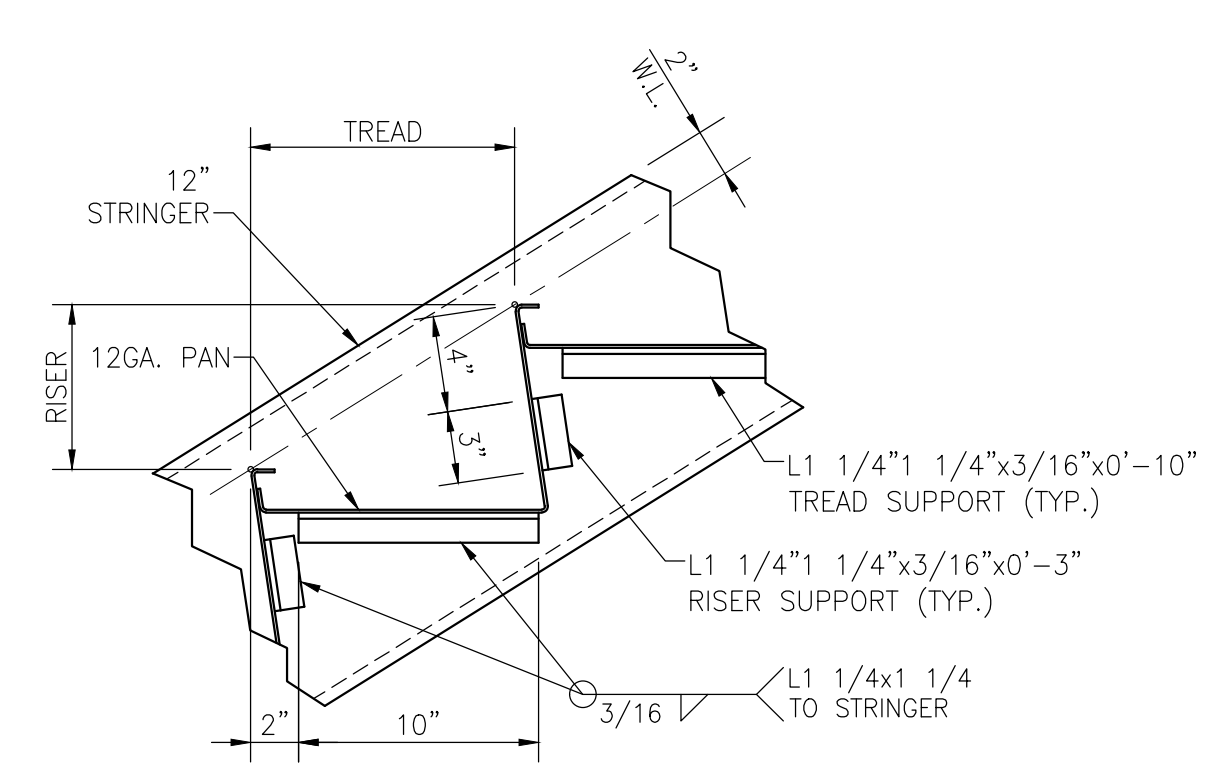

TYPICAL TREAD SUPPORT ANGLE LOCATION
SCALE: 1 1/2"=1'-0"

ALL MATERIAL SHOWN ON THIS DRAWING SHALL RECEIVE ONE COAT OF STANDARD SHOP PRIMER U.N.O.

STAIR A FABRICATION DETAILS	
DRAWN BY: KSB	PROJECT NUMBER
CHECKED BY: TS	21-175
SCALE: AS NOTED	SD-7

2			
1			
0	5/24/22	ISSUE FOR FABRICATION	TS
NO.	DATE	REVISION DESCRIPTION	ISSUED BY